

BASIC LINE

CAV TP3.8

Overall dimension

Double-side Manual Release 2-Post Lift



3800 | KG

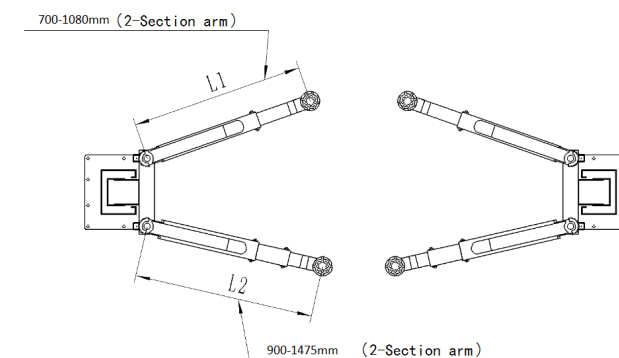
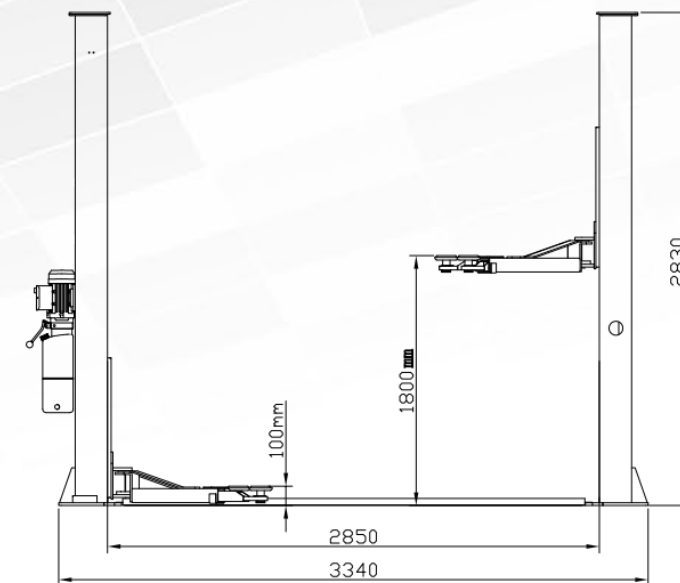

Highlights

- 3800KG lifting capacity, ideal starter model with a TOP price - performance ratio for auto repair workshop
- Double-side manual unlocking system, easy operating and handling
- Strong synchronization cables and cable pulley ensures safety and durability.
- 2-stage asymmetric and telescopic lifting arms as standard
- Automatic lifting arm lock & unlock system
- Chain lifting system combined with high quality hydraulic cylinders
- Max.lifting height switch protects cylinders and ensures safety
- Low lifting point 100mm, also perfectly suitable for sports vehicles
- Each lift passed the 115% rated capacity dynamic loading test and 150% static loading test

Specifications

CAV TP3.8

Capacity	3800kg
Max.Lifting height	1800mm
Min.height	100mm
Lifting time	45-50s
Power of motor	2.2kW